

319. Development of Electropneumatic Servo System with Reference Model Based Signal Adaptive Force Controller

A. Grigaitis, V.-A. Geleževičius

Dept. of Control Technology, Kaunas University of Technology, Studentų str. 48, LT-51367 Kaunas, Lithuania;

e-mail: arunas.grigaitis@mechanika.lt, vilius.gelezevicius@ktu.lt

(Received 5 September 2007; accepted 10 October 2007)

Abstract. Due to pneumo-mechanical power conversion process nonlinearities and process parameters (volumes and initial pressures of pneumatic cylinder working chambers) on line change it is problematic to ensure satisfactory control quality of pneumatic proportional servo drive. Considering that all nonlinearities are concentrated in the force generation stage, application of adaptive force control mode is suggested. Electropneumatic servo drive with reference model based signal adaptive force controller is developed and investigated in this paper. It is presented the strategies of reference model choice and are given control quality investigation results of electropneumatic servo system.

Keywords: electropneumatic, nonlinearities, investigation, chamber, reference model, controller.

Introduction

Electro-pneumatic actuators are widely used in industrial automation, such as robotics, handling devices, packing machines and so on. Features of pneumatic-mechanical power conversion process do not manifest in the case when it is used control mode “from back to back”, but it has significant influence on control quality when it is applied proportional control principle by using proportional directional control valves and feedback technology.

On purpose to minimise the influence of nonlinearities of pneumatic cylinder and directional control valve on dynamical behaviour of electropneumatic proportional servo drive it is proposed and investigated the model reference based on adaptive control method of force regulation. Adaptive control method practice allows ensuring desirable dynamical behaviour of pneumatic cylinder developed force in spite of changing initial conditions such as start position of the piston and initial pressures in the working chambers of cylinder. This creates favourable conditions for higher level control loops development using traditional hierarchical control strategy of cylinder piston velocity and its position.

Development of dynamical model of symmetric pneumatic acting system

Functional diagram of pneumatic force generation system consisting of rodless pneumatic cylinder and electropneumatic proportional control valves is presented in Fig. 1.

Dynamical model of the pneumatic actuator was developed on the base of the following fundamental relationships:

a) the ideal gas law, supposing the pressures and temperature within the cylinder chambers being homogeneous and kinetic and potential energy terms – negligible:

$$P = \frac{m \cdot R \cdot T}{\eta \cdot V}, \quad (1)$$

where $R=8,31 \frac{Nm}{mol \cdot deg}$ – the ideal gas constant, m – mass, kg ; T – temperature, $^{\circ}K$; η – mass of the gas mole, kg ; V – volume of the gas, m^3 .

b) the supplied gas through orifice of directional control valve mass flow rate dependence on the orifice cross section area and acting pressures behind and before valve:

$$\frac{dm}{dt} = C_q \cdot C_m \cdot A_v \frac{P_{in}}{\sqrt{T}}, \quad (2)$$

where: C_q – orifice discharge coefficient $C_q = 0,7$; A_d – orifice area, m^2 ; T – supply temperature, $^{\circ}K$; p_{in} – supply pressure, bar ; C_m – mass flow coefficient depending on pressures behind and before directional control valve ratio.

c) the equations defining mechanical force generation and cylinder dynamics conditions:

$$\begin{cases} p_{1,2}(t) = \frac{RT}{\eta} \int \left(\frac{dm_{1,2}}{dt} \right) dt \\ F_c(t) = [\pm p_1(t) \mp p_2(t)]S \\ v_c(t) = \frac{1}{m} \int (F_c(t) \mp F_R(t)) dt \\ \Delta l_c = \int v_c(t) dt \\ V_{1,2}(t) = [V_{0(1,2)} \pm \Delta l_c]S, \end{cases} \quad (3)$$

where: $p_{1,2}$ – pressures in the cylinder chambers, Pa ; $V_{1,2}$ – volumes of the cylinder chambers, m^3 ; $F_c(t)$ – developed force of the cylinder, N ; $F_R(t)$ – force of the resistance, N ;

v_c – velocity of the cylinder piston, m/s ; Δl – piston displacement, m ; S – working surface area of the piston, m^2 .

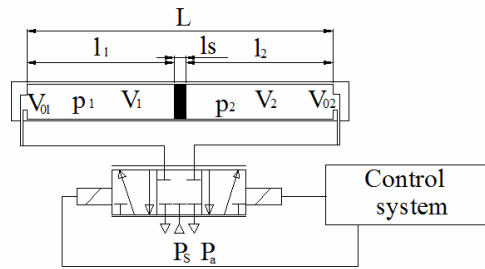

Fig. 1. Functional diagram of electropneumatic acting system

Functional diagram of developed dynamical model of pneumatic actuator [1] presented in Fig. 2 distinctly demonstrates complexity of pneumo-mechanical force generation process and its dependence on initial piston position and pressures into working chambers of the cylinder.

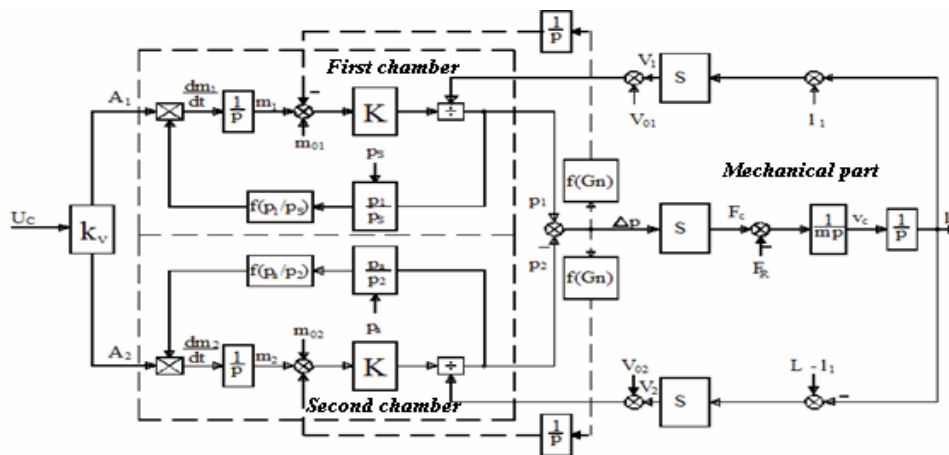

Fig. 2. The structural model of the pneumatic system

Modeling results of force generation process of the pneumatic cylinder, presented in Fig. 3 and Fig. 4, clearly demonstrate oscillating nature of the cylinder developed force and strong dependence of dynamical behavior of the force on initial conditions, such as initial piston position and initial pressures in the working chambers of the cylinder.

Simulation was carried out using rodless cylinder with 25 mm diameter piston and 300 mm stroke and proportional directional control valve MPYE-5-1/8. Modeling results presented in Fig. 3 was got when cylinder piston was posed in the middle stroke position and initial pressures were equal to 3 and 6 bars, while modeling results presented in Fig. 4 was got when cylinder piston was posed in the 0.1 and 0.2 m stroke position and initial pressures were equal to 3 bars.

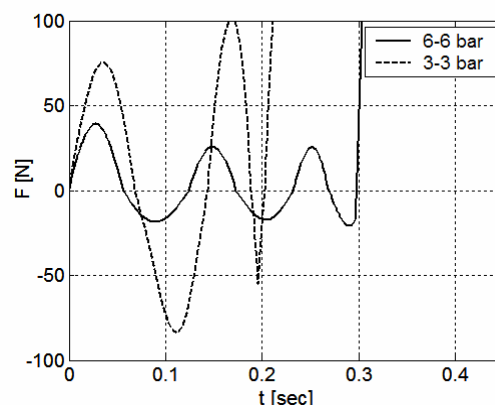

Fig. 3. Influence of initial pressure in working chambers on dynamical behavior of generated force

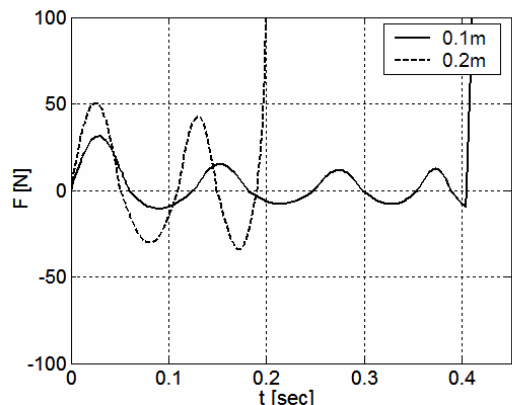

Fig. 4. Influence of initial piston position on dynamical behavior of generated force

Design and investigation of pneumatic cylinder adaptive force controller

The nonlinear force generation process parameters such as volumes and pressures of working chambers of pneumatic cylinder are rapidly changing, consequently it is proposed to apply pneumatic cylinder developed force regulation system based on the reference model for signal adaptive control technology [2]. Proposed system is presented in Fig. 5. Proposed force control technology of pneumatic cylinder developed force can be implemented by applying commonly known feed-back principle based control contour with main force controller in supplement with additional reference model based signal adaptive contour, generating additional control signal to main controller on purpose to compensate an influence of control system parameters change on process control quality.

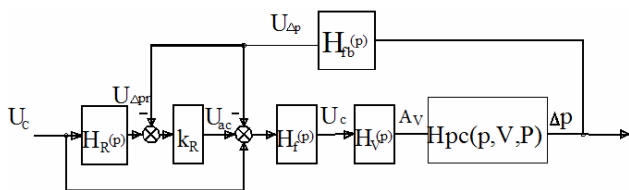

Fig. 5. Functional diagram of adaptive force control system

The functional diagram of adaptive force control system is presented in Fig. 5. There is presented pneumatic cylinder by nonlinear transfer function $H_{pc}(p, V, P)$ in the diagram. Force controller $H_f(p)$, proportional directional control valve $H_v(p)$ and feed back sensor $H_{fb}(p)$ with pneumatic cylinder all together form the main force control contour.

Supposing the parameters of pneumatic cylinder being constant (pneumatic cylinder is stopped) the force controller was adjusted under the quantitative optimum condition expressed by transfer function of open loop of force regulation contour in the form as follows [3]:

$$H_{op}(p) = H_f(p)H_v(p)H_{pc}(p, V, P)H_{fb}(p) = \frac{1}{2T_\mu p(T_\mu p + 1)}, \quad (4)$$

where: T_μ – freely chosen small time constant defining the desired rapidity of force regulation process.

Supposing the quality of adjusted in such way force control contour as desirable for the whole electropneumatic acting system, the transfer function of reference model for adaptive force control contour can be defined as:

$$H_R(p) = \frac{U_{\Delta pr}(p)}{U_{rp}(p)} = \frac{1}{2T_\mu^2 p^2 + 2T_\mu p + 1}. \quad (5)$$

Transfer function of adaptive controller $H_{ac}(p)$ is defined on the whole force control process stability condition using conventional design methods.

Controller of main force control contour was adjusted for particular working point of the cylinder, when piston of cylinder was stopped in the middle stroke, pressures in the working chambers were constant. In this case transfer function of pneumatic cylinder $H_{pc}(p, V, P)$ can be expressed as transfer function of the first order with constant coefficients:

$$H_{pc}^*(p) = \frac{\Delta p}{\Delta A} = \frac{k_c^*}{T_c p + 1}, \quad (6)$$

where: $k_c^* = \frac{\Delta p}{A_v}$, A_v – orifice area of valve, m^2 ; T_c – time constant.

According to catalogue data [4] the transfer function of proportional directional control valve also can be expressed in the form of the first degree delay circuit:

$$H_A(p) = \frac{\Delta A_v}{\Delta U_c} = \frac{k_v}{T_v p + 1}, \quad (7)$$

where time constant T_v approximately is equal to 0,05s.

Supposing the T_μ being equal to T_v and $H_{fb}(p) = k_p$, on the base of (6) the transfer function of main force controller can be defined as:

$$H_f(p) = \frac{T_c^* p + 1}{2k_A k_c^* k_p T_A P}. \quad (8)$$

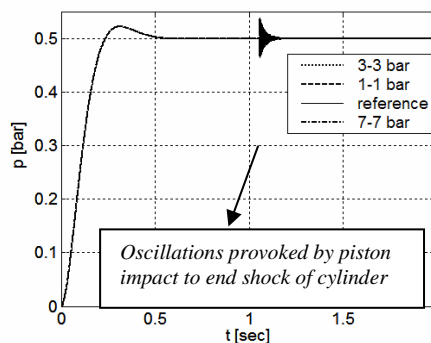

Fig. 6. Dynamical behavior of pneumatic force control process with different initial pressures in the working chambers

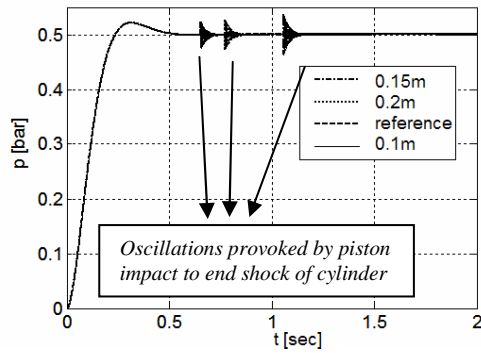

Fig. 7. Dynamical behavior of pneumatic force control process when initial position of cylinder piston is changing

Modeling results of reference model based on signal adaptive electro-pneumatic force control system are presented in Fig. 6 and Fig. 7.

These results demonstrate high efficiency of proposed adaptive force regulation technique. It is distinctly seen that dynamical response curve of pneumatic cylinder developed force provoked by reference signal step mode change corresponds to quantitative optimum condition and does not depend on initial piston position and initial pressures in working chambers of the cylinder.

Development of velocity control system of pneumatic cylinder with adaptive force controller

Development of higher hierarchy level controllers of pneumatic servo system such as velocity controller of pneumatic cylinder can be carried out using well known hierarchical system design methods based on quantitative optimum condition fulfilling. Supposing the adaptive force control system being well functioning, the transfer function of the whole force control contour can be taken equal to the transfer function of the reference model (5). After approximation this function is equal to the function of the first order, the transfer function of the force regulation system is taken as:

$$H_{FC}(p) = \frac{1}{2T_{\mu}p + 1}, \tag{9}$$

and on the base of functional diagram presented in Fig. 8 with respect to the quantitative optimum condition can be designed the velocity controller of pneumatic servo drive. This condition leads to the use of simple proportional velocity controller.

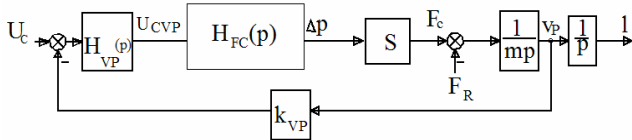

Fig. 8. Functional diagram of electropneumatic servo system with adaptive force controller

Modeling results of velocity control system of pneumatic cylinder with adaptive force controller are presented in Fig. 9 and Fig. 10.

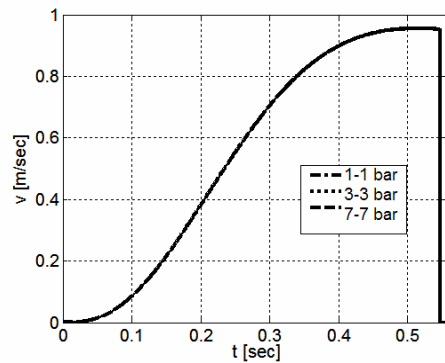

Fig. 9. Piston velocity response curves with different initial pressures in the working chambers

These results demonstrate that velocity of cylinder piston does not depend on initial piston position and initial pressures in working chambers of the cylinder.

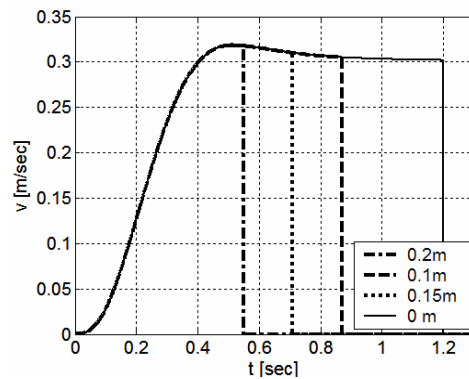

Fig. 10. Piston velocity response curves when initial position of cylinder piston is changing

Conclusions

1. Electro-pneumatic servo system force regulation with the reference model based on signal adaptive control method allowing eliminating nonlinearities influence of pneumatic cylinder and directional control valve is proposed and investigated in this paper.
2. The adaptive force controller is designed in the base of conventional force regulation loop with addition contour consisting of reference model of optimal force control system giving reference signal for controller compensating nonlinearities and initial conditions influence on pneumatic cylinder force control process quality.
3. The velocity controller of pneumatic servo drive can be designed using conventional methods based on respect of the quantitative optimum conditions, supposing that dynamic parameters of force control contour correspond to parameters of the reference model and are stationary.

References

- [1] **Geleževičius V. A., Grigaitis A.** Investigation of dynamic behaviour of nonlinear electropneumatic acting system // Electronics and Electrical Engineering. – Kaunas: Technologija, 2006. – No 4. - 35-40 p.
- [2] **Borcov J. A., Poliachov N. A., Putov V. V.** Elektromechaničeskije sistemy s adaptivnym i modalnym upravleniem. Leningrad, Elerktroatomizdat, 1984. 215 p.
- [3] **Geleževičius V.** Elektros pavarų valdymo sistemos / K. Kriščiūnas, V. Kubilius, Vilnius, Mokslas, 1990. 360 p.
- [4] Informatikon on www.catalog.festo.com/enu.
- [5] **Geleževičius V. A., Grigaitis A.** Research of adaptive force control loop of electropneumatic acting system // Electronics and Electrical Engineering. – Kaunas: Technologija, 2007. – No 6.